

A large blue magnifying glass graphic is centered on the page. The handle of the magnifying glass extends from the bottom left towards the center. The lens is a large yellow circle with a white border, containing the text "DATA SHEET" and "ES-11-XQ007-0300-XXXXX".

DATA SHEET

ES-11-XQ007-0300-XXXXX

CONTENTS

1. Introduction
2. Feature & Application
3. Mechanical Dimensions
4. Electro Optical Parameters
5. Limit Parameters
6. Chromaticity Coordinate
7. Characteristic Curves
8. Packaging Specification

ES-11-XQ007-0300-XXXXX Datasheet



Our product has excellent reliability & high quality. Everstar COB series covers a wide range of luminous flux.

The element arrangement in LED package is capable of utilizing light more effectively with higher performance.



FEATURES

- High color quality, high flux, high efficacy
- Low thermal resistance
- Long lifetime
- Easy for assemble
- RoHS compliant
- Available in white chromaticity bins form ANSI

APPLICATIONS

- LED bulb lights
- LED spot lights
- LED recessed lights
- LED miner lights
- Commercial lighting
- Domestic lighting
- Museum lighting

Mechanical Dimensions

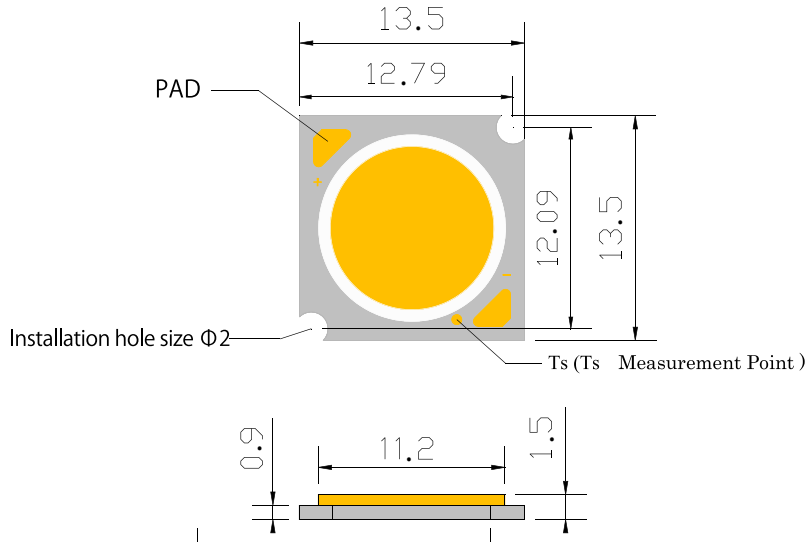

All dimensions are in millimeters (mm), tolerances are ± 0.25 mm.

Electro Optical Parameters

CCT	Power		Luminous Flux		Current		Voltage		CRI	Efficacy
	Typ	Max	Typ	Max	Typ	Max	Typ	Max		
2700K			819	1105						>130
3000K			850	1147						>135
4000K	6.3	8.5	882	1190	300	390	21	21.7	80	>140
6000K			900	1215						>143

The tolerance of measurement at our tester is luminous flux $\pm 10\%$
 Luminous flux inside the integrating sphere measurements.

Absolute Maximum Ratings

Item	Symbol	Min	Max	Unit
Forward Current	I_F	/	390	mA
Operating Temperature	T_{opr}	-10	+85	°C
Storage Temperature	T_{stg}	-40	+100	°C
Soldering Temperature	T_{sol}	/	350	°C
Junction temperature	T_j	/	125	°C
Thermal Resistance	R_{j-c}	/	2.8	°C/W
Antistatic Ability	ESD	2000	/	V
Max Power Consumption	P	/	8.5	W

The using temperature is less than 85°C; please reduce the using current or contact with us if using temperature is more than 85°C.

When hand soldering,keep the temperature of iron below less 350°C less than 5seconds.

Chromaticity Coordinate Groups

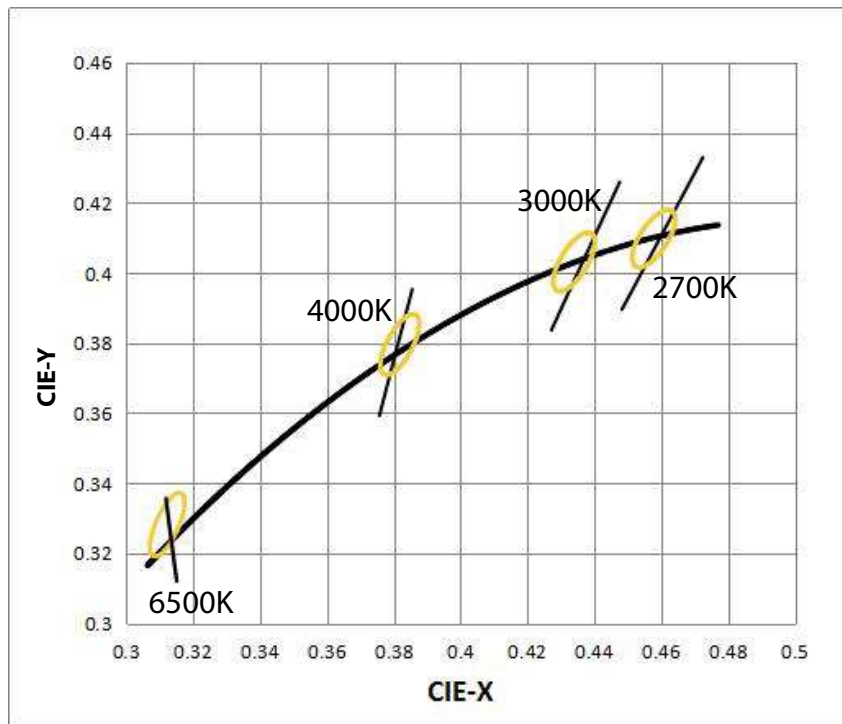

Standard type	ANSI/A	
	CIE-X	CIE-Y
2700K	0.4577	0.4098
3000K	0.4339	0.4032
4000K	0.3818	0.3796
6500K	0.3123	0.3283

FD maintains chromaticity (x, y) ± 0.005 , color region stay within MacAdam 3-step ellipse from the chromaticity center.

The ANSI standard is A standard for short, reference standard is ANSI-C78.377-2011.

The using current should be consistent with the label, and chromaticity will change if working current is outside this range of the label.

Characteristic Curves

Forward Voltage vs Forward Current

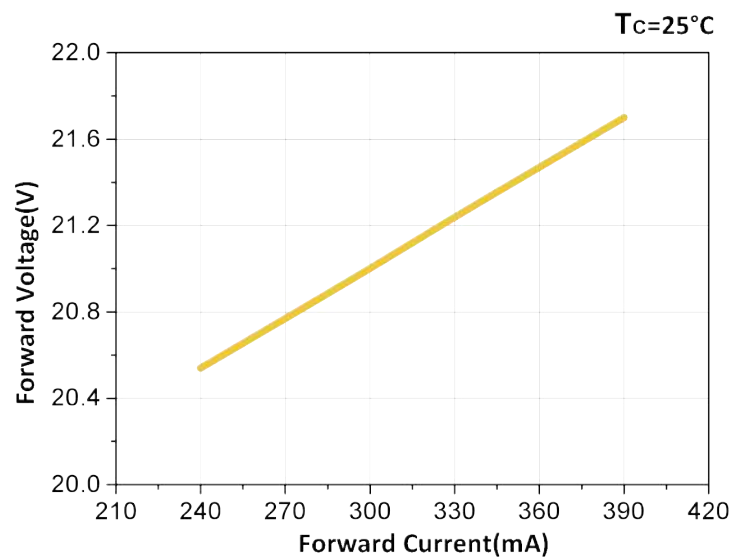

Relative Luminous Flux vs Forward Current

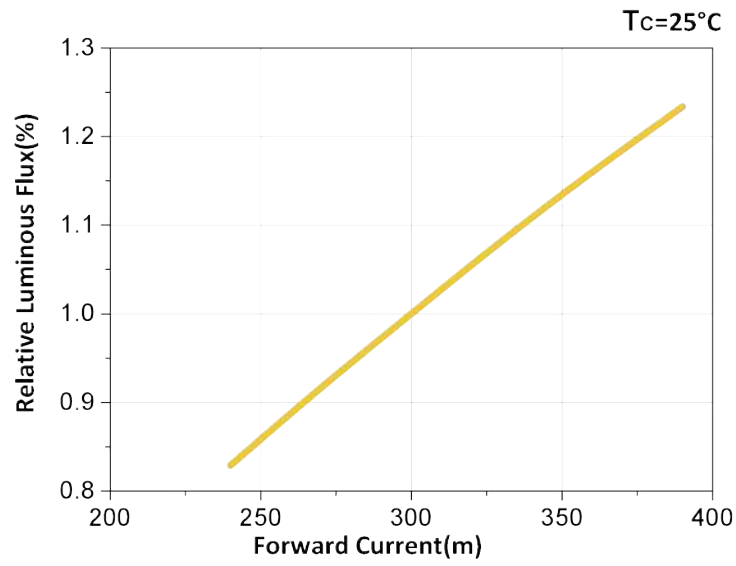

Relative Luminous Intensity vs Substrate Temperature

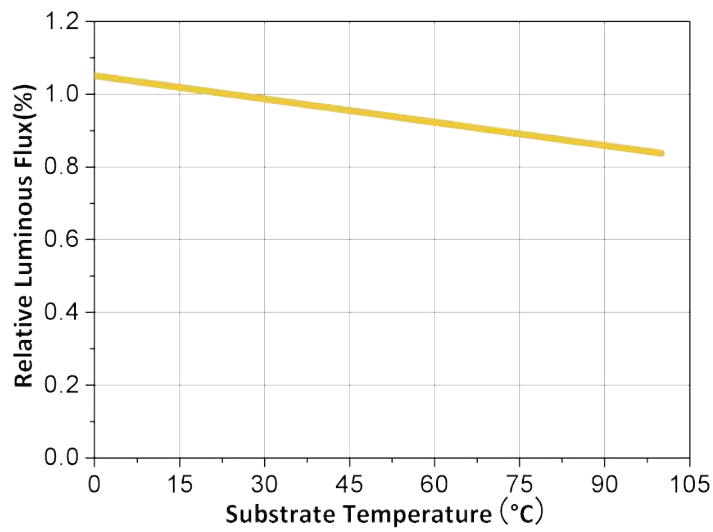

Radiation Angle

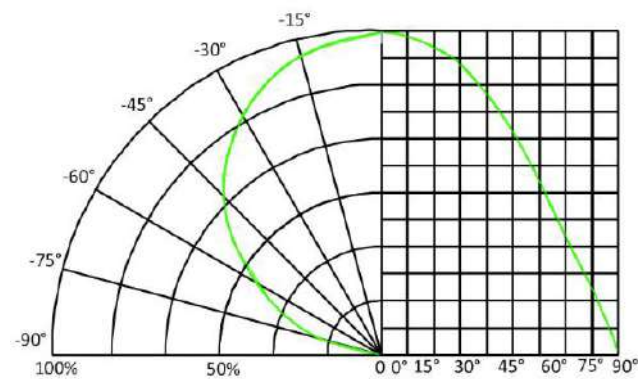

Manner of packing

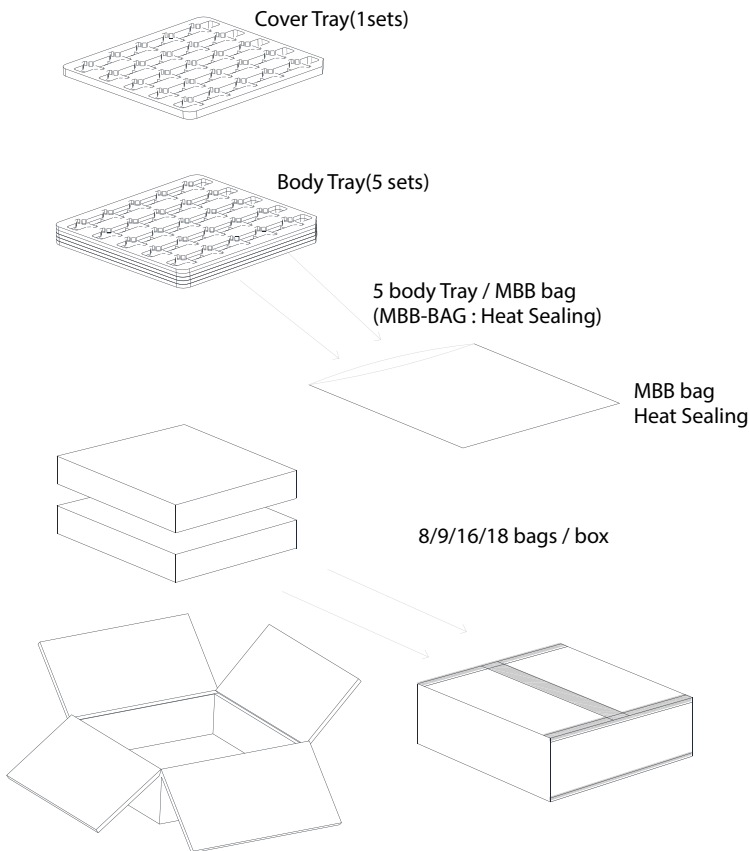
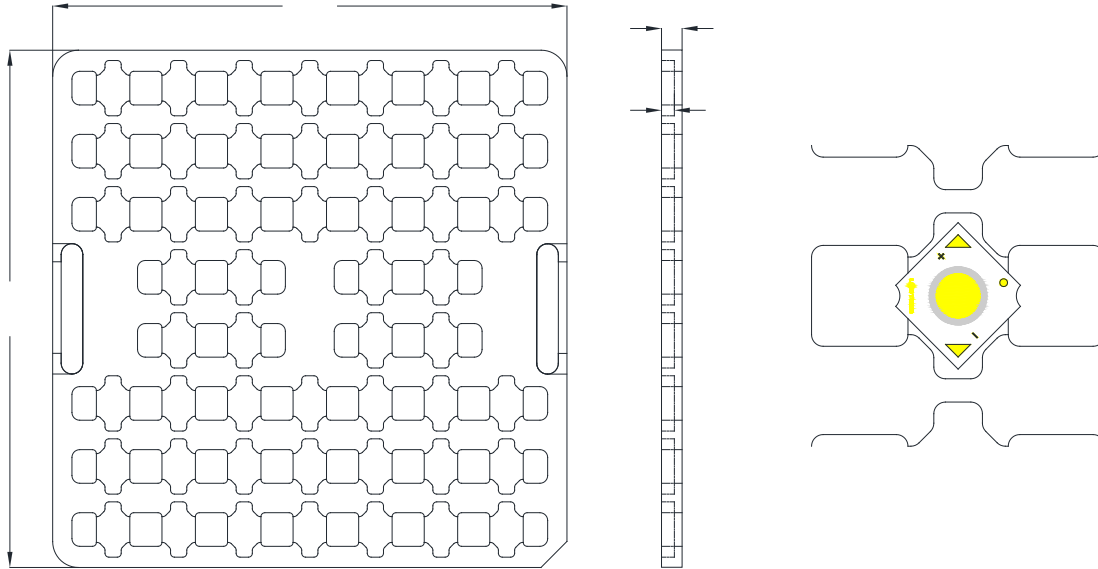

1)
An electrostatic bag contains five sets, and a set contains 50 PCS of COB .(Smallest packing unit:250 PCS)

2)
A white label contains , product name, quantity and lot number is placed on the electrostatic bag. (Tray Dimension: 200*200*8 mm) Cover Tray(1sets)

Cautions

Storage

Store the parts in a dry, nitrogen- purged cabinet or container that actively maintains the temperature at 20 - 30 and the RH at no greater than 60%.

Precautions for Use

By using anti - static - electricity bracelets/ cushions/ overalls/ shoes/gloves and anti - static - electricity containers, it can effectively prevent static electricity and surge. The soldering iron point should be properly grounded. When hand soldering, keep the temperature of iron below less 350°C and less than 5seconds

ESD Protection

You need to take the protective measures for the product being sensitive to static electricity. It can lead to product damage electricity is beyond the maximum rating. The ground resistance if the high voltage current made by static can't beyond 10 Ω .

Cleaning

Please do not make the thermal grease, oil exposed to the light - emitting surface. Airgun can be used to remove dirt. Gun's Pressure: 0.5MPa, Time: 1 to 2 seconds, Distance: more than 20cm.

Overcurrent Protection

It is recommended to design PCB with ground circuit. Pay special attention to the operating environment of the products: Humidity must be between 50% and 80%, or else electrostatic breakdown and overcurrent damage occur. The operating temperature is -10°C ~ 85°C. When using this product, please observe the absolute maximum ratings and the instructions for operating outlined in these data sheets. Company do not assume any responsibility for any damage, resulting from use of product which does not comply with the absolute maximum rating.

