

A large graphic of a magnifying glass with a blue handle and a yellow lens. The lens is centered on the page and contains the text "DATA SHEET" and "ES-11-XQ007-0200-XXXX".

DATA SHEET

ES-11-XQ007-0200-XXXX

CONTENTS

1. Introduction
2. Feature & Application
3. Mechanical Dimensions
4. Electro Optical Parameters
5. Limit Parameters
6. Chromaticity Coordinate
7. Characteristic Curves
8. Packaging Specification



ES-11-XQ007-0200-XXXXX Datasheet

Our product has excellent reliability & high quality. Everstar COB series covers a wide range of luminous flux.

The element arrangement in LED package is capable of utilizing light more effectively with higher performance.



FEATURES

- High color quality, high flux, high efficacy
- Low thermal resistance
- Long lifetime
- Easy for assemble
- RoHS compliant
- Available in white chromaticity bins form ANSI

APPLICATIONS

- LED bulb lights
- LED spot lights
- LED recessed lights
- LED miner lights
- Commercial lighting
- Domestic lighting
- Museum lighting

Mechanical Dimensions

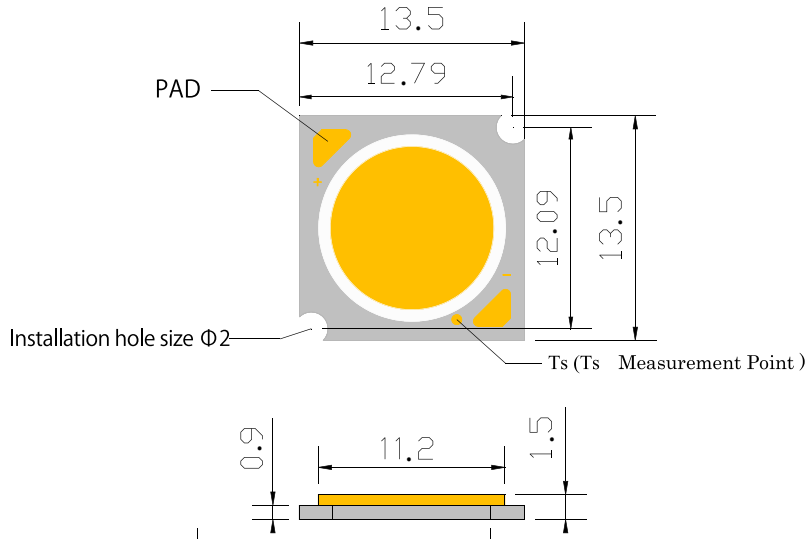

All dimensions are in millimeters (mm), tolerances are ± 0.25 mm.

Electro Optical Parameters

Parameters	Conditions	Min	Typ	Max	Unit
Forward V	IF=200mA	34	36	40	V
Forward A		120	200	300	mA
Luminous Flux IF=200mA	TC=2700K	800	850	920	LM
	TC=3000K	830	885	950	
	TC=4000K	885	940	1000	
	TC=5000K	-	-	-	
	TC=5700K	-	-	-	
	TC=6000K	860	920	980	
	TC=6500K	-	-	-	
Power	IF=200mA	-	7	9.2	W
Ra		80	-	-	

Note:

- 1) device tolerance for luminous flux: $\pm 4\%$
- 2) device tolerance for color coordinate: ± 0.002
- 3) device tolerance for forward voltage: $\pm 0.1V$
- 4) device tolerance for angle : ± 5 degrees

Absolute Maximum Ratings

Item	Symbol	Min	Max	Unit
Operating Temperature	T_{opr}	- 10	+85	°C
Storage Temperature	T_{stg}	- 40	+100	°C
Soldering Temperature	T_{sol}	/	350	°C
Junction temperature	T_j	/	125	°C
Thermal Resistance	R_{j-c}	/	1.34	°C/W
Antistatic Ability	ESD	2000	/	V

Note:

The temperature of Aluminum PCB do not exceed 85°C.

When hand soldering, keep the temperature of iron below 350°C and for less than 5 seconds

Chromaticity Coordinate Groups

White bins on CIE -1931 ($T_a=25^\circ\text{C}$)

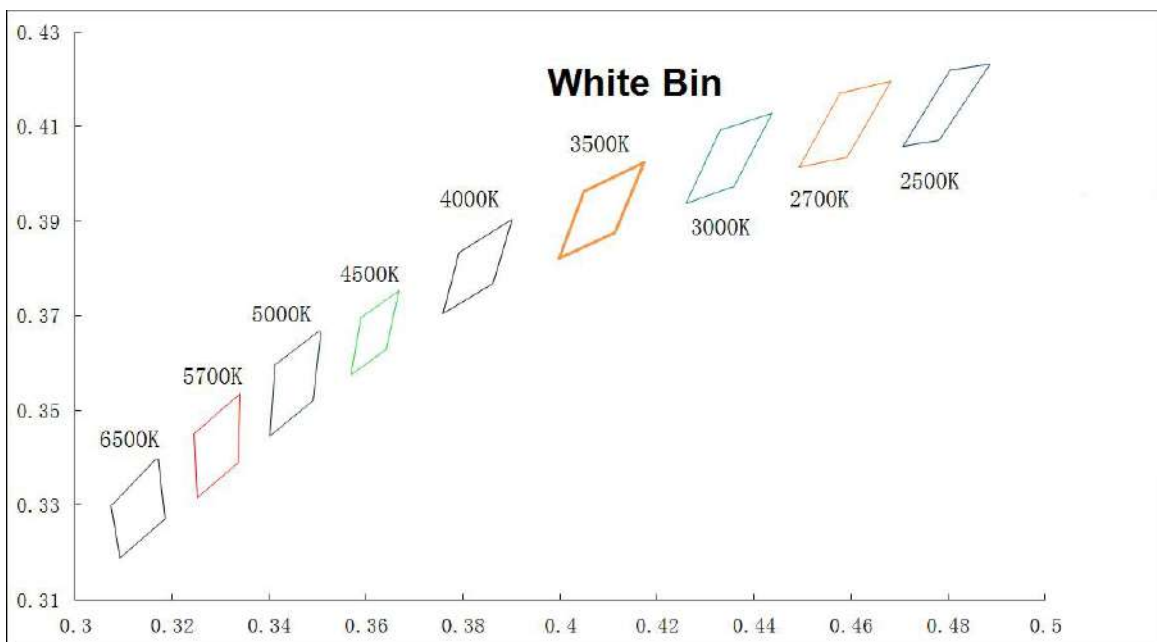

Color Temperature and BIN

CT	2500K	2700K	3000K	3500K	4000K	4500K	5000K	5700K	6000K	6500K
CT Range	2410-2550	2640-2810	2940-3140	3330-3580	3820-4120	4375-4635	4840-5200	5400-5900	5700-6300	6150-6850
CT Factor	± 70	± 85	± 100	± 125	± 150	± 130	± 180	± 250	± 300	± 350
Center CT	2480	2725	3045	3465	3985	4503	5028	5665	6000	6530

6500K	0.3178	0.3336		0.3184	0.3271		0.3093	0.3188		0.3084	0.3243
6000K	0.3152	0.3370		0.3167	0.3241		0.3277	0.3330		0.3274	0.3470
5700K	0.3338	0.3463		0.3336	0.3390		0.3251	0.3315		0.3248	0.3383
5000K	0.3498	0.3595		0.3490	0.3520		0.3401	0.3446		0.3406	0.3521
4500K	0.3667	0.3753		0.3654	0.3691		0.3579	0.3636		0.3589	0.3697
4000K	0.3901	0.3904		0.3881	0.3836		0.3774	0.377		0.3791	0.3835
3500K	0.4173	0.4025		0.4143	0.3951		0.4023	0.3892		0.4048	0.3963
3000K	0.4436	0.4129		0.4397	0.4051		0.4294	0.4015		0.4328	0.4092
2700K	0.4681	0.4196		0.4636	0.4116		0.4535	0.4092		0.4577	0.4171
2500K	0.4885	0.4232		0.4833	0.4152		0.414	0.422		0.4885	0.4232

Characteristic Curves

Forward Current / Radiation/ Temperature Characteristics

Luminous flux efficiency vs operating power (blue line)

Relative Luminous Flux vs Operating power (yellow line)

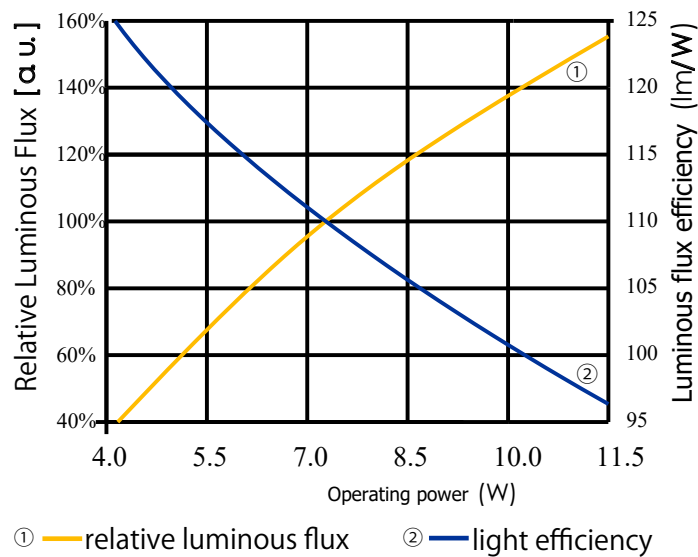

Relative Luminous Intensity vs Substrate Temperature

If= 200mA

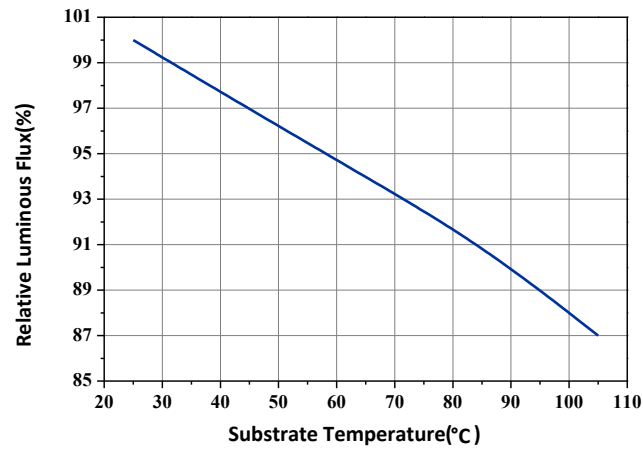

Forward Voltage vs Substrate Temperature

If= 200mA

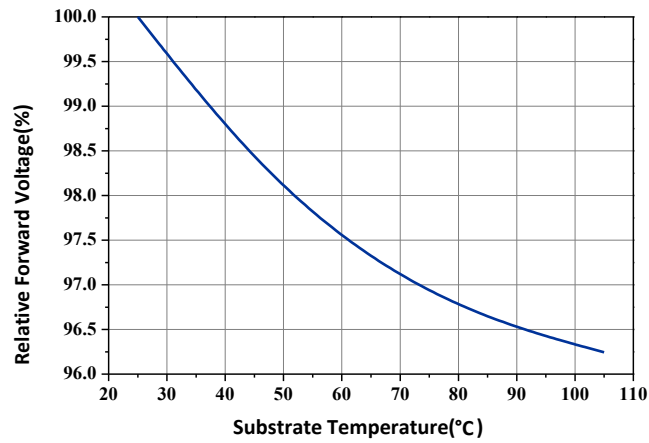

Radiation Angle

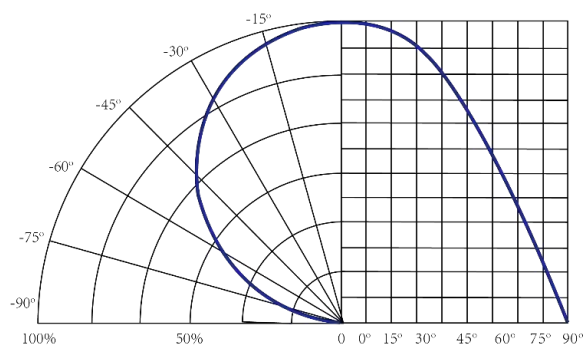

Color Shift Characteristics

Δ CIE x, Δ CIE y vs Forward Current
CRI(Ra)=80 Tc =25°C If= 200mA

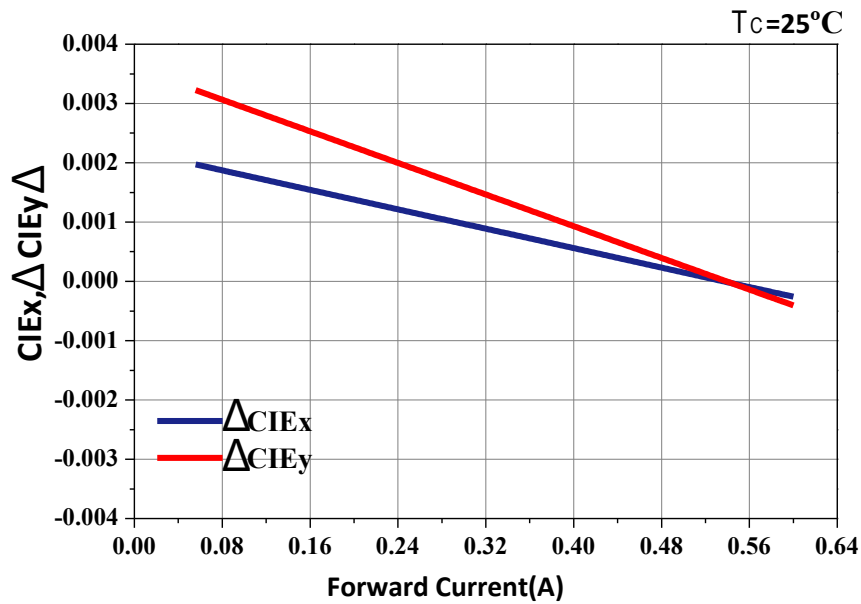

Δ CIE x, Δ CIE y vs Substrate Temperature
CRI(Ra)=80 Tc =25°C If= 200mA

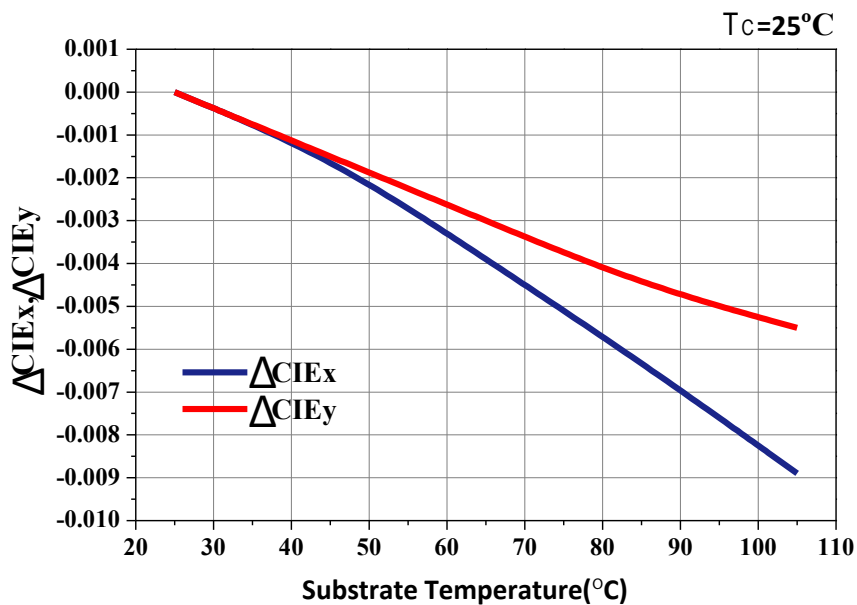

Spectrum Distribution

Relative Intensity vs Wavelength

If=200mA

CRI(Ra) 80Min

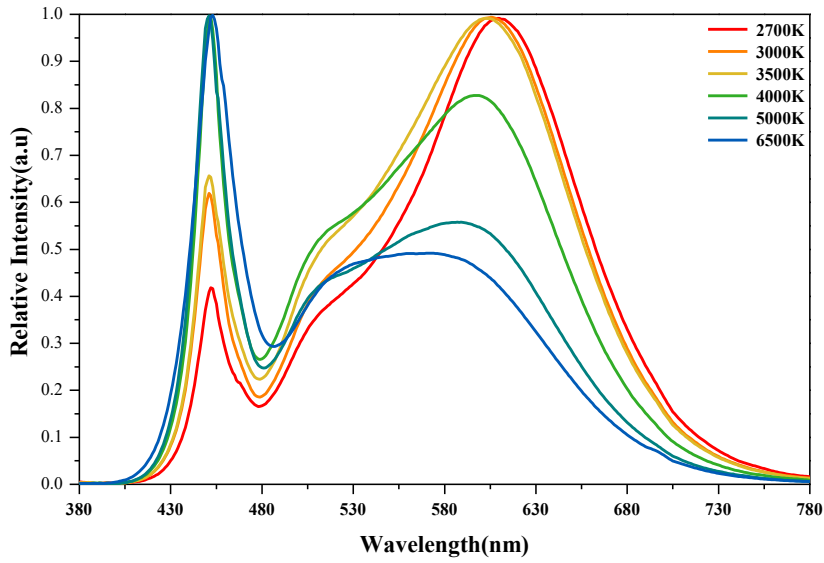

CRI(Ra) 90Min

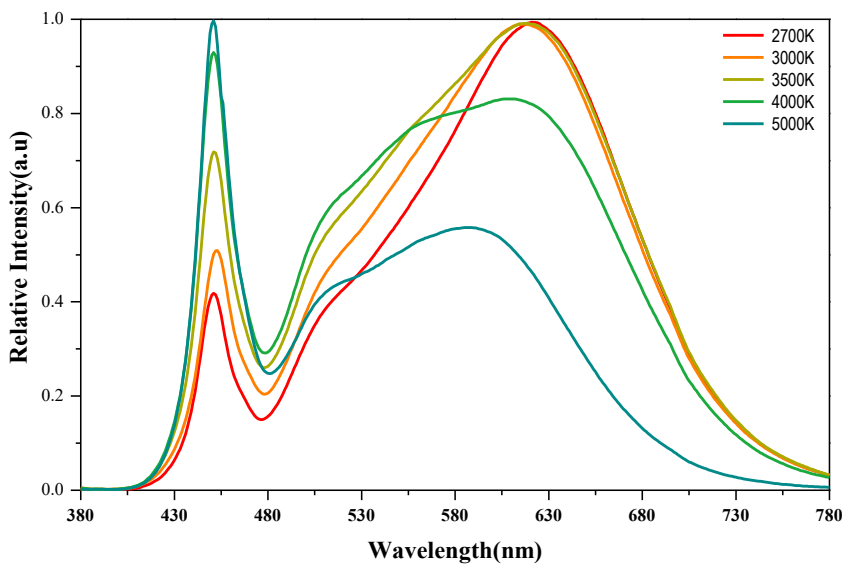

Manner of packing

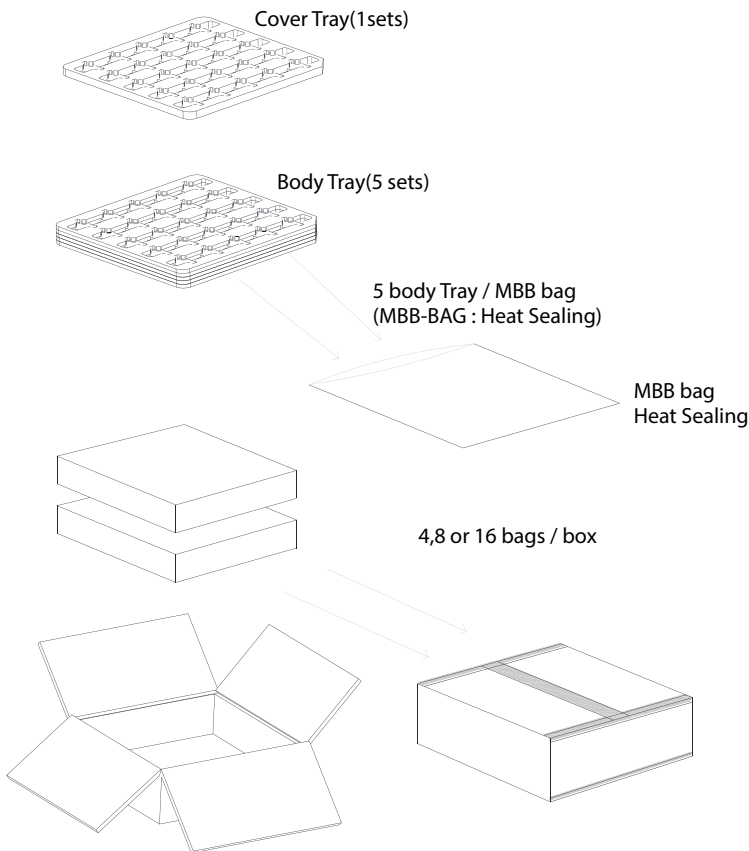
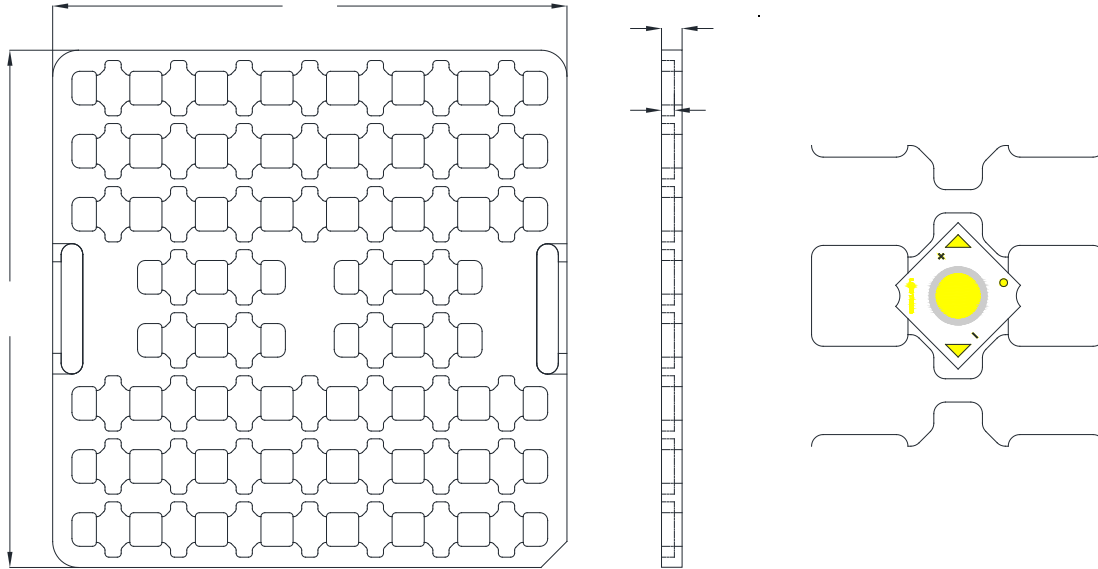

1)
An empty tray is placed on top of a 5-tier tray which contain 50 PCS each. (Smallest packing unit:250 PCS)

2)
A label with product name, quantity and lot number is placed on the upper empty tray. (Tray Dimension:200*200*8 mm)

Cautions

Storage

Store the parts in a dry, nitrogen- purged cabinet or container that actively maintains the temperature at 20 - 30 and the RH at no greater than 60%.

Precautions for Use

By using anti - static - electricity bracelets/ cushions/ overalls/ shoes/gloves and anti - static - electricity containers, it can effectively prevent static electricity and surge. The soldering iron point should be properly grounded. When hand soldering, keep the temperature of iron below less 350°C and less than 5 seconds

ESD Protection

You need to take the protective measures for the product being sensitive to static electricity. It can lead to product damage electricity is beyond the maximum rating. The ground resistance if the high voltage current made by static can't beyond 10 Ω .

Cleaning

Please do not make the thermal grease, oil exposed to the light - emitting surface. Airgun can be used to remove dirt. Gun's Pressure: 0.5MPa, Time: 1 to 2 seconds, Distance: more than 20cm.

Overcurrent Protection

It is recommended to design PCB with ground circuit. Pay special attention to the operating environment of the products. Humidity must be between 50% and 80%, or else electrostatic breakdown and overcurrent damage would occur. The operating temperature is -10°C ~ 85°C. When using this product, please observe the absolute maximum ratings and the instructions for operating outlined in these data sheets. Company do not assume any responsibility for any damage, resulting from use of product which does not comply with the absolute maximum rating.