



Product Specification

Product Name: 105W micro infrared remote control LED driver
Product Model: LDP-105M150 CE UL
LDP-105R150 CE UL
Rev. A.1

Address: Sangtai Industrial Park Guanwai
Xiaobaimang Songbai Road
Nanshan District, Shenzhen
City, Guangdong Province, P.R.China
Post Code: 518108
TEL: 0755-27657000
FAX: 0755-27657908
E-mail: moso@mosopower.com
Web site: <http://www.mosopower.com>

Prepared By	Checked By	Approved By

Reference standard literature

1. UL 8750-2009 Light Emitting Diode(LED) Equipment for Use in Lighting Products

2. GB 19510.1-2009 灯的控制装置 第一部分 一般要求和安全要求

IEC61347-1 Lamp control gear-Part 1:General and safety requirements

3. GB 19510.14-2009 灯的控制装置 第四部分 LED 模块用直流或交流电子控制装置的特殊要求

IEC61347-2-13 Lamp control gear-Part 2-13:Particular requirements for d.c or a.c. supplied electronic control gear for LED modules

4. GB 7000.5 -2005 道路与街路照明灯具安全要求

IEC60598-1-2008 Luminaires– Part 1: General requirements and tests

5. EN55015 Limits and methods of measurement of radio disturbance characteristics of electrical lighting and similar equipment

6. GB17625.1 电磁兼容 限值 谐波电流发射限值(设备每相输入电流≤16A)

IEC61000-3-2 Electromagnetic compatibility(EMC)-Part 3-2:Limits-Limits for harmonic current emissions(equipment input current≤16A per phase)

7. IEC61000-3-3 Electromagnetic compatibility(EMC)-Part 3-3:Limits-Limitation of voltage changes, voltage fluctuations and flicker in public low-voltage supply systems,for equipment with rated current ≤16 A per phase and not subject to conditional connection

8. IEC61547 Equipment for general lighting purposes- EMCimmunity requirements

9. GB17743 电气照明和类似设备的无线骚扰特性的限值和测量方法

Contents

1	Scope	1
2	Input Characteristics	1
	2.1 Input Voltage And Frequency.....	1
	2.2 AC Input Current.....	1
	2.3 Inrush Current (Cold Start)	1
	2.4 Power Factor	1
	2.5 Efficiency	1
	2.6 THDi	2
	2.7 Standby power consumption	2
3	Output Characteristic	2
	3.1 Output Power	2
	3.2 Output Voltage and Current	2
	3.3 Output Current Ripple.....	3
	3.4 Cold Start Turn-On Delay Time.....	3
	3.5 Output Current Overshoot	3
	3.6 Line Regulation (Input Voltage Regulation).....	3
	3.7 Load Regulation.....	3
4	Dimming Control	4
	4.1 Function.....	4
	4.2 Define of Connect Interface	4
	4.3 Dimming Interface.....	4
	4.4 Dimming Curve.....	5
5	Protect Function	5
	5.1 Short Circuit Protect	5
	5.2 Over Output Voltage Protect.....	5
	5.3 Over Temperature Protect	5
6	Efficiency vs Output Voltage Curve	6
7	Power Factor vs Load Power Curve	7
8	Output Power vs Input Voltage Curve	7
9	Safety And Electromagnetic Compatibility	8
	9.1 Safety Standards.....	8
	9.2 Electromagnetic Compatibility Standards.....	8
10	Details Of Safety Specifications	8
	10.1 Dielectric Strength.....	8
	10.2 Grounding Resistance.....	9
	10.3 Leakage Current	9
	10.4 Insulation Resistance.....	9
	10.5 Surge Immunity Test.....	9



11	Environmental Specifications	9
	11.1 Operated Temperature And Humidity	9
	11.2 Storage Temperature And Humidity	9
	11.3 Degrees of Protection.....	9
12	Reliability	9
	12.1 Mean Time Between Failure (MTBF) Qualification (According as MIL-HDBK-217F Standards)	9
	12.2 Life Time Qualification.....	9
	12.3 Maximum Case Temperature Tc	9
	12.4 Vibration.....	10
	12.5 Drop Test	10
13	Mechanical Outline Drawing	10
14	Label	11
	14.1 Label of OEMarking.....	11
	14.2 Label of UL Marking.....	12
15	Weight	12

1 Scope

This document defines the electrical, mechanical and environmental specifications of a 105W micro infrared remote control LED driver. The LED driver shall meet the RoHS requirement.

This enclosure of LED driver is:

- With AL Case With Plastic Case Open Frame Others

2 Input Characteristics

2.1 Input Voltage And Frequency

Item	Minimum	Rated Value	Maximum
Input Voltage	90Vac	100-277Vac	305Vac
Input Frequency	47Hz	50/60 Hz	63Hz

2.2 AC Input Current

Under 25°C±10°C ambient temperature, rated input and output range (reference output power - input voltage curve), maximum AC input current is 1.5A.

2.3 Inrush Current (Cold Start)

Under 25°C±10°C ambient temperature, 230Vac input, the peak value of the inrush current is less than 75 A.

2.4 Power Factor

2.4.1 Under 25°C±10°C ambient temperature, 115Vac input, 100%load, the typical value of power factor is 0.98, the minimum value is 0.97;

2.4.2 Under 25°C±10°C ambient temperature, 230Vac input, 100%load, the typical value of power factor is 0.96, the minimum value is 0.95;

2.4.3 Under 25°C±10°C ambient temperature, 230Vac input, 80%load, the typical value of power factor is 0.95, the minimum value is 0.95.

2.5 Efficiency

2.5.1 Under 25°C±10°C ambient temperature, 115Vac input, 75V output voltage, 100%load, the typical value of efficiency is 89%, the minimum value is 87%;

2.5.2 Under 25°C±10°C ambient temperature, 230Vac input, 75V output voltage, 100%load, the typical value of efficiency is 91%, the minimum value is 89%;

2.5.3 Under 25°C±10°C ambient temperature, 230Vac input, 107V output voltage, 100%load, the typical value of efficiency is 92%, the minimum value is 90%;

2.5.4 Under 25°C±10°C ambient temperature, 230Vac input, 150V output voltage, 100%load, the typical value of efficiency is 92%, the minimum value is 90%.

2.6 THDi

2.6.1 Under 25°C±10°C ambient temperature, 115Vac input, 100%load, THDi is less than 15%;

2.6.2 Under 25°C±10°C ambient temperature, 230Vac input, 100%load, THDi is less than 15%;

2.6.3 Under 25°C±10°C ambient temperature, 230Vac input, 80%load, THDi is less than 15%

2.7 Standby power consumption

Under 25°C±10°C ambient temperature, rating input voltage, the average value of standby power consumption is less than 10W.

3 Output Characteristic

3.1 Output Power

Under full input voltage range(reference output power - input voltage curve), the maximum value of output power is 105 W.

3.2 Output Voltage and Current

Item (Unit)	Value	Test Condition (Under 25°C±10°C Ambient Temperature)
Adjust Range of Output Current (A)	0.14~1.40	full input voltage range ^[1]
Leave Factor Range of Output Voltage(V)	60~75	full input voltage range
Adjust Range of Output Voltage(V)	60~150	full input voltage range
Error of Output Current	±5% ^[2]	full input voltage range, full load range
No Load Output Voltage (V)	≤170V	full input voltage range
Leave Factory Default Output Spec	75V ^[3]	full input voltage range
	1.40A ^[4]	full input voltage range

Note: 1. reference output power - input voltage curve;
2. depended on maximum output current;
3. leave factory default full load rating output voltage;
4. default output current can setting.

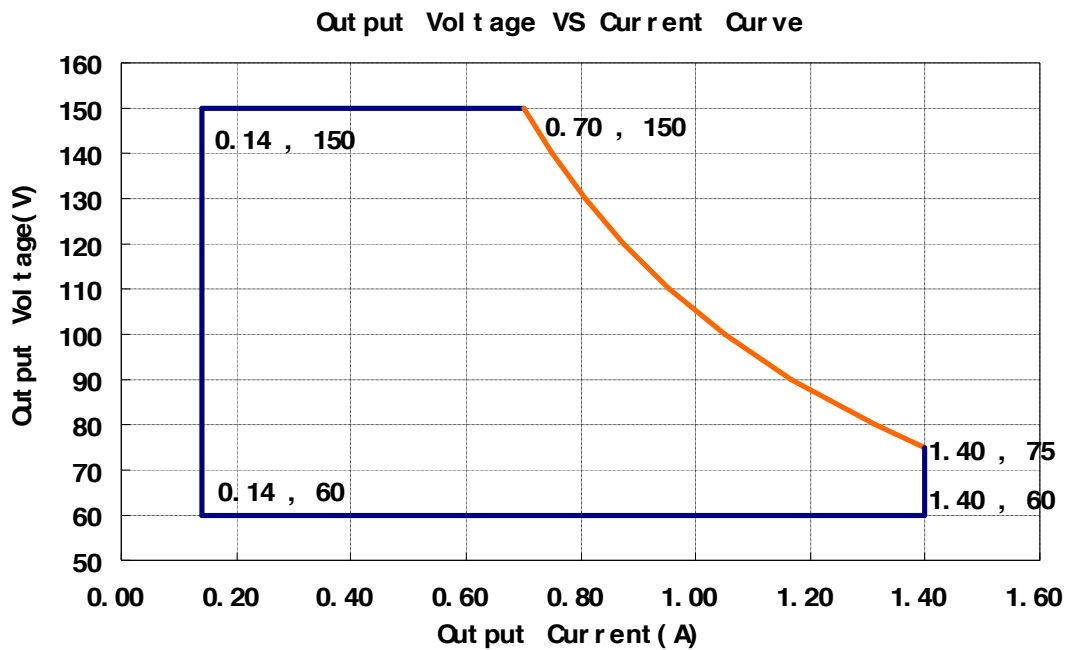

3.3 Output Current Ripple

Under $25^{\circ}\text{C}\pm 10^{\circ}\text{C}$ ambient temperature, 230Vac input, 100%load, the ratio of output current ripple⁽¹⁾ peak-peak value and rated output current is less than 16%

Note: load is LED, ripple is different with difference LED load.

3.4 Cold Start Turn-On Delay Time

Under $25^{\circ}\text{C}\pm 10^{\circ}\text{C}$ ambient temperature, 115-277Vac input, 100%load, turn-on delay time at cold start is less than 3000ms.

3.5 Output Current Overshoot

Under $25^{\circ}\text{C}\pm 10^{\circ}\text{C}$ ambient temperature, 115-277Vac input, LED full load, the ratio of output current overshoot and rated output current is less than 10%

3.6 Line Regulation (Input Voltage Regulation)

Under $25^{\circ}\text{C}\pm 10^{\circ}\text{C}$ ambient temperature, 100%load, change input from 115Vac to 305Vac, the Line Regulation (Input Voltage Regulation) is less than 1%

3.7 Load Regulation

Under $25^{\circ}\text{C}\pm 10^{\circ}\text{C}$ ambient temperature, 230Vac input voltage, change load from 50%to 100%, Load Regulation is less than 3%

4 Dimming Control^[1]

Note:For model LDP-105M150 only

4.1 Function

Function	0-10V	PWM	Time Control
Yes Or No	√	√	√

Note: 1. Normal leave factory product does not have time control function, MOSO will supply standard setting software for user to program when user need time control.
2. User can setting five time section. Customer can change the output current and the time depend on "MOSO Programmer User Manual".

4.2 Define of Connect Interface

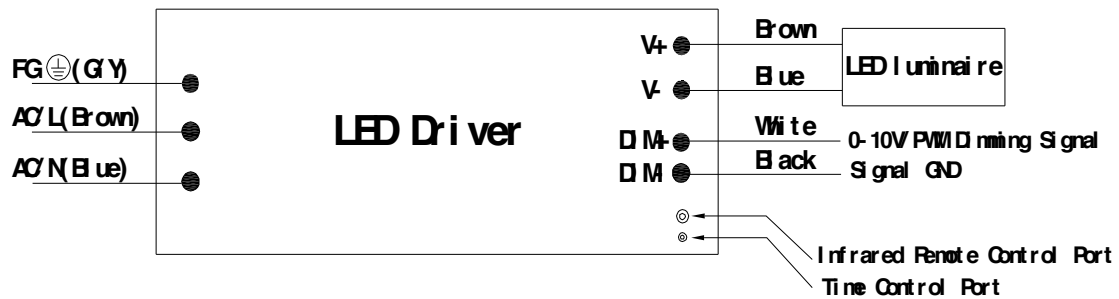

Wire	Colour	Note
AC Input	Brown, blue, yellow/green	for CE
	White, black, green	For UL
DC Output	Brown, blue	for CE
	Red, black	For UL
Dimming	White, black	

4.3 Dimming Interface

Mode	Electrical Interface	
PWM Dimming	Frequency	250Hz~1000Hz
	High Voltage Level	9.7~10.3V or 4.85~5.15V
	Low Voltage Level	0~0.3V
	Snk Current	<2.0 mA
	Open Circuit of Dimming	100% output current
	Linear Dimming Range	10%~100%dr
	Short Circuit of Dimming	10%dr output current
0-10V Dimming	Dimming Signal Voltage	0~10Vpp (±1%)
	Snk Current	<2.0 mA
	Open Circuit of Dimming	100% output current
	Linear Dimming Range	10%~100%dr
	Short Circuit of Dimming	10%Ir output current

Note: 1. When connect external dimmer to LED driver, for the external driver, the maximum sink current should >70uA, maximum output current should >2mA;
2. Ir is maximum output current;

3. PWM dimming mode: detect outside PWM duty, change the output current depend the PWM duty, change the output current depending on proportion;
4. 0-10V dimming mode: detect outside voltage level of 0-10V dimming signal, change the output current depend the voltage level; change the output current depending on proportion;
5. At two in one dimming mode, the maximum revolution definition is 1% at PWM mode, when voltage level of PWM is less than 10V, 99% duty is 100% output, 100% duty is process as 0-10V dimming signal;
6. Can setting to 0-5V dimming by programmer.

4.4 Dimming Curve

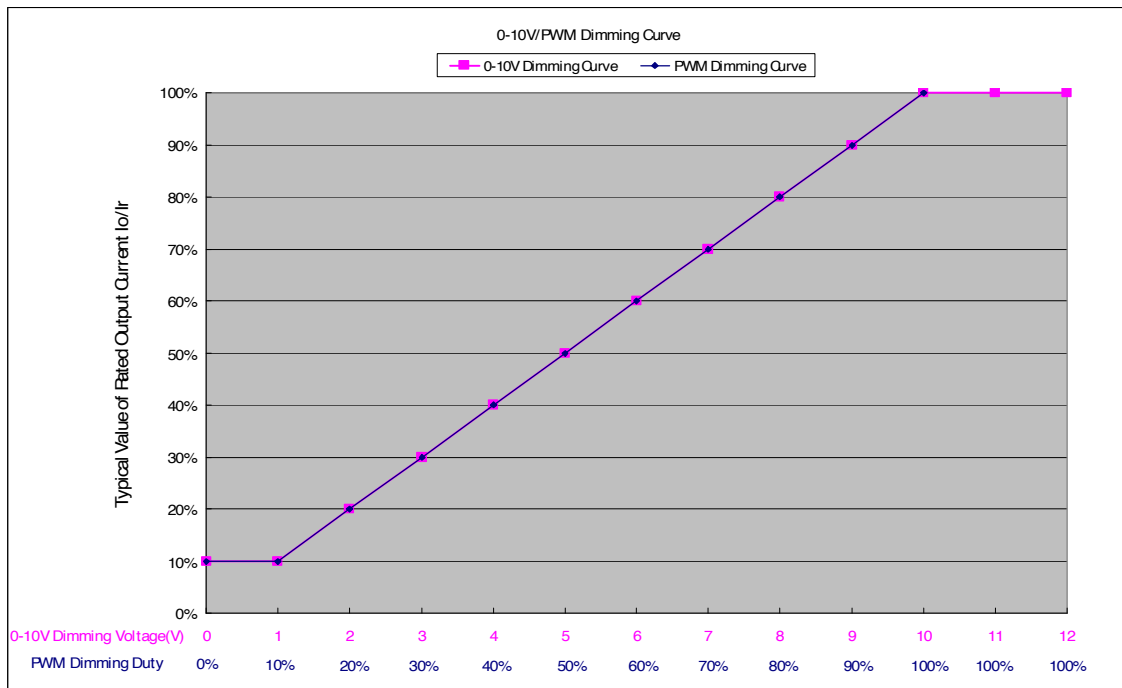

5 Protect Function

5.1 Short Circuit Protect

The average value of input power shall less than 10W when the output rail short, the power supply shall be self-recovery when the fault condition is removed.

5.2 Over Output Voltage Protect

Output voltage is $165 \pm 5V$, the power supply shall be enter over output voltage protect model, should restart power supply when fault condition is removed.

5.3 Over Temperature Protect

When the temperature of power supply enclosure is over $85^{\circ}C$, the output of power supply shall decrease. Output current is limited in 30% (typ.) . meet the demand of double 85, at the maximum operation temperature $125^{\circ}C$, operate two hours and do not damage.

6 Efficiency vs Output Voltage Curve

$V_{in} = 115V_{ac}$ $T_a = 25^{\circ}C$

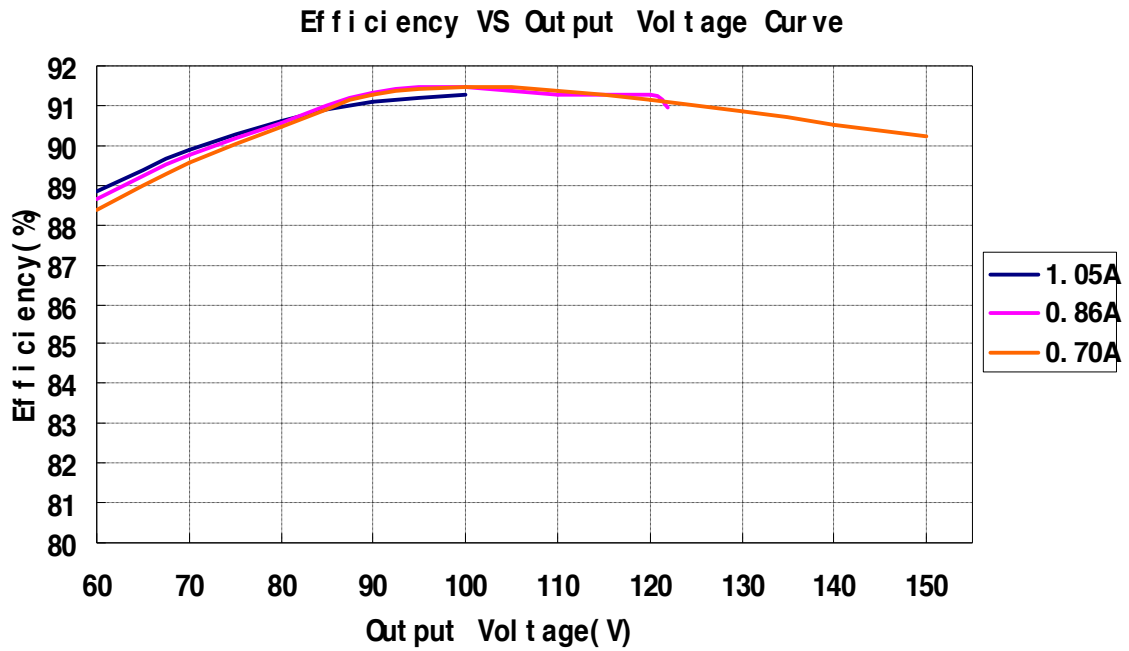

$V_{in} = 230V_{ac}$ $T_a = 25^{\circ}C$

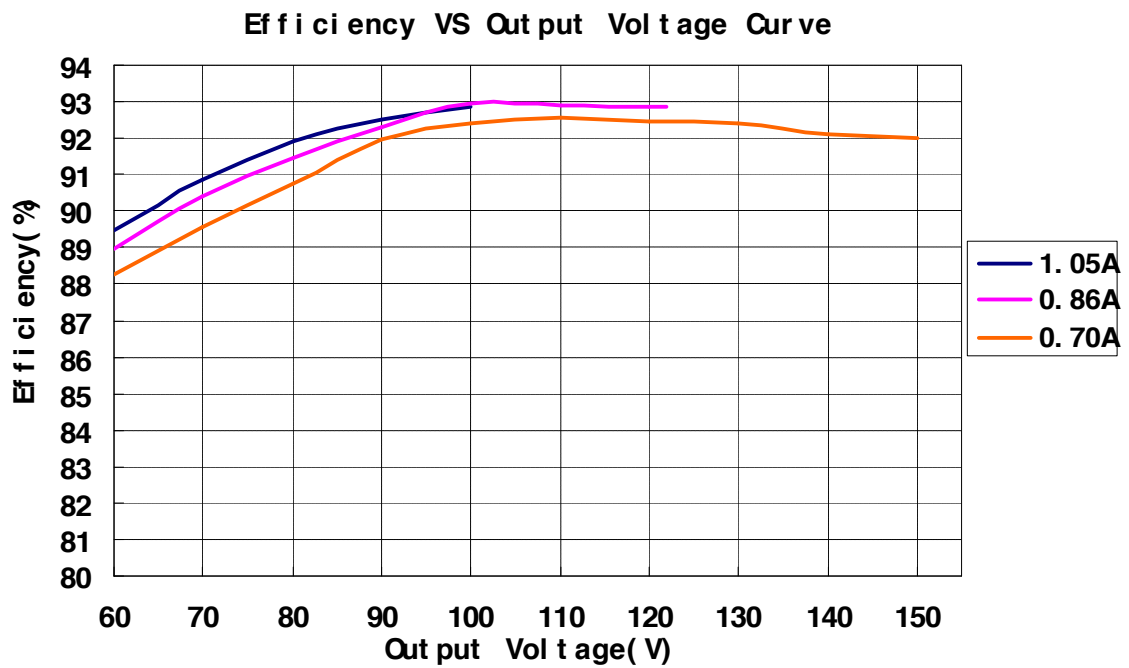

7 Power Factor vs Load Power Curve

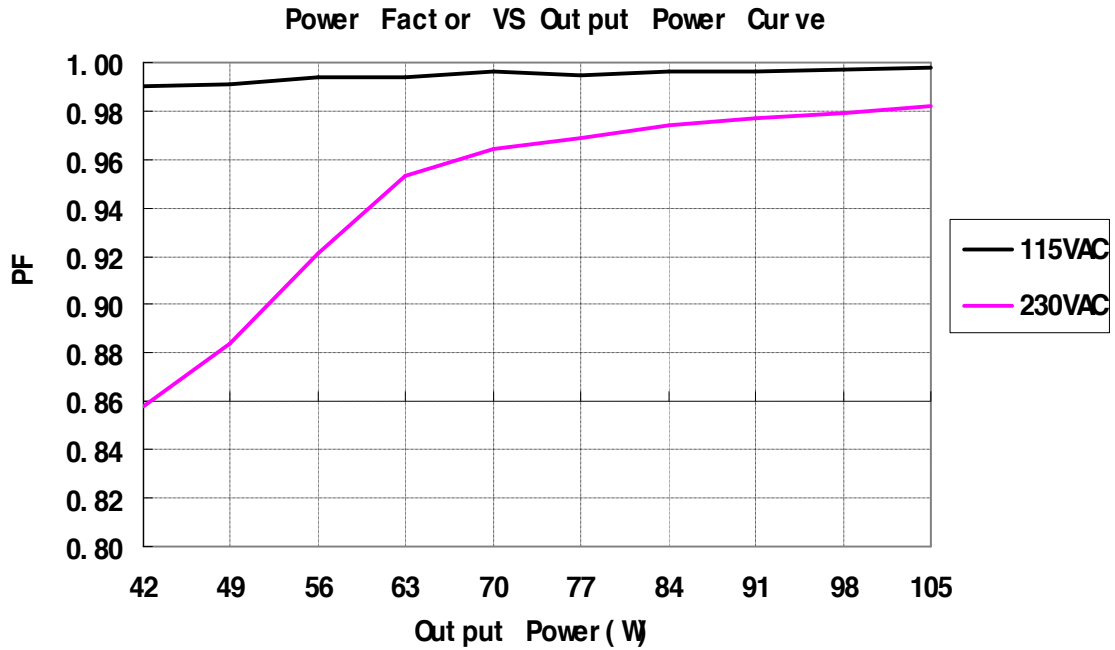

8 Output Power vs Input Voltage Curve

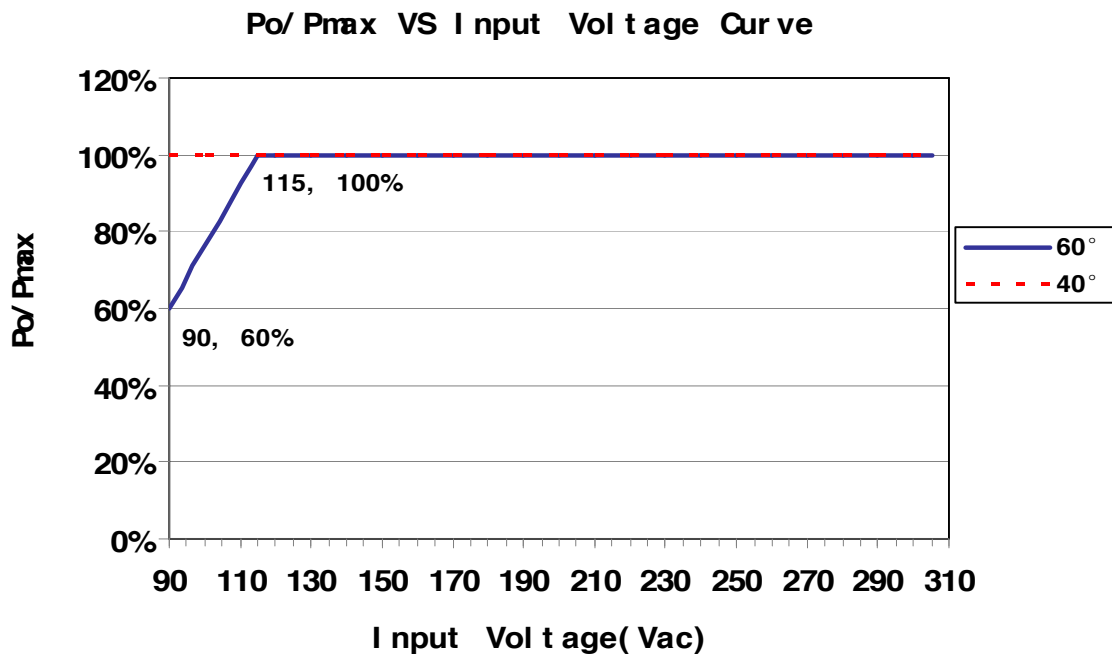

9 Safety And Electromagnetic Compatibility

9.1 Safety Standards

Safety Certification	Country and region	Standards	Whether have Certification
CCC	China	GB19510.1	√
		GB19510.14	
CE	Europe	EN61347-1	√
		EN61347-2-13	
CB	CB member	IEC61347-1	√
		IEC61347-2-13	
UL	America	UL 8750	√
		UL 1310 (Class 2 Power Units)	
		UL 1012	
CUL	Canada	CSA C22.2 No.107.1-01	√
		CSA C22.2 No.223-M91 (Power Supplies With Extra-Low-Voltage Class 2 Outputs)	
KC	Korea	K61347-1	
		K61347-2-13	
		K62384	
PSE	Japan	J61347-1	
		J61347-2-13	
SAA	Australia	IEC61347-2-13	
		AS/NZS61347.1	

9.2 Electromagnetic Compatibility Standards

EMCCertification	Country and region	Standards	Whether have Certification
CCC	China	GB 17743	√
		GB 17625.1	
CE	America Europe	EN 55015 CLASSB(input 230Vac)	√
		IEC61000-3-2	
		IEC61000-3-3	
		IEC61547	
KC	Korea	K61547	
		K00015	
PSE	Japan	J55015	
FCC	America	FCC part 15(input 115Vac)	

10 Details Of Safety Specifications

10.1 Dielectric Strength

10.1.1 input to output : 3750Vac, 60s, current is less than 10mA;

10.1.2 input to FG: 1600Vac, 60s, current is less than 10mA;

10.1.3 output to FG: 1600Vac, 60s, current is less than 10mA.

Note: 25°C±10°C ambient temperature, I/P: L,N Line; O/P: Vo+, Vo-.

10.2 Grounding Resistance

Under $25^{\circ}\text{C}\pm 10^{\circ}\text{C}$ ambient temperature, pass 25A current for 60s, the measured grounding resistance is less than 0.1Ω .

10.3 Leakage Current

Leakage Current is defined as the current flowing through the ground wire. Under $25^{\circ}\text{C}\pm 10^{\circ}\text{C}$ ambient temperature and 230Vac/50Hz input, the leakage current shall be less than 0.75mA.

10.4 Insulation Resistance

Under $25^{\circ}\text{C}\pm 10^{\circ}\text{C}$ ambient temperature and less than 70% relative humidity, apply 500V dc voltage to each port of Input to output, input to GND, output to GND and last 60s, the insulation resistance at least $50\text{M}\Omega$.

10.5 Surge Immunity Test

Under $25^{\circ}\text{C}\pm 10^{\circ}\text{C}$ ambient temperature, L line to N line is 4000V, L line to earth is 6000V, N line to earth is 6000V.

Estimate of test result is depending on GB/T 17626.5-2008/IEC 61000-4-5:2005: temporary loss of function or temporary degradation of performance not requiring an operator.

11 Environmental Specifications

11.1 Operated Temperature And Humidity

11.1.1 Temperature: -40°C to $+60^{\circ}\text{C}$;

11.1.2 Relative Humidity: 20% to 95%, non-condensing.

11.2 Storage Temperature And Humidity

11.2.1 Temperature: -40°C to $+85^{\circ}\text{C}$

11.2.2 Relative Humidity: 20% to 95%, non-condensing.

11.3 Degrees of Protection

IP67

12 Reliability

12.1 Mean Time Between Failure (MTBF) Qualification (According as MIL-HDBK-217F Standards)

Mean time between failure is at least 200,000 hours under 25°C ambient temperature, 230Vac input, and 80% load.

12.2 Life Time Qualification

The life time is at least 50,000 hours, under 45°C case temperature, 230Vac input, and 80% load.

12.3 Maximum Case Temperature T_c

Under 60°C ambient temperature, 115Vac input and maximum load, the maximum case temperature is 85°C .

12.4 Vibration

10 to 500HZ Sweep at constant acceleration of 1.0G (depth: 3.5mm) for 1 Hour for each of the perpendicular axes X, Y, Z

12.5 Drop Test

Ten times 60cm drop test with one angle three edges and six face of complete package, package shall not damage, product function and dielectric strength should meet the requirement.

13 Mechanical Outline Drawing

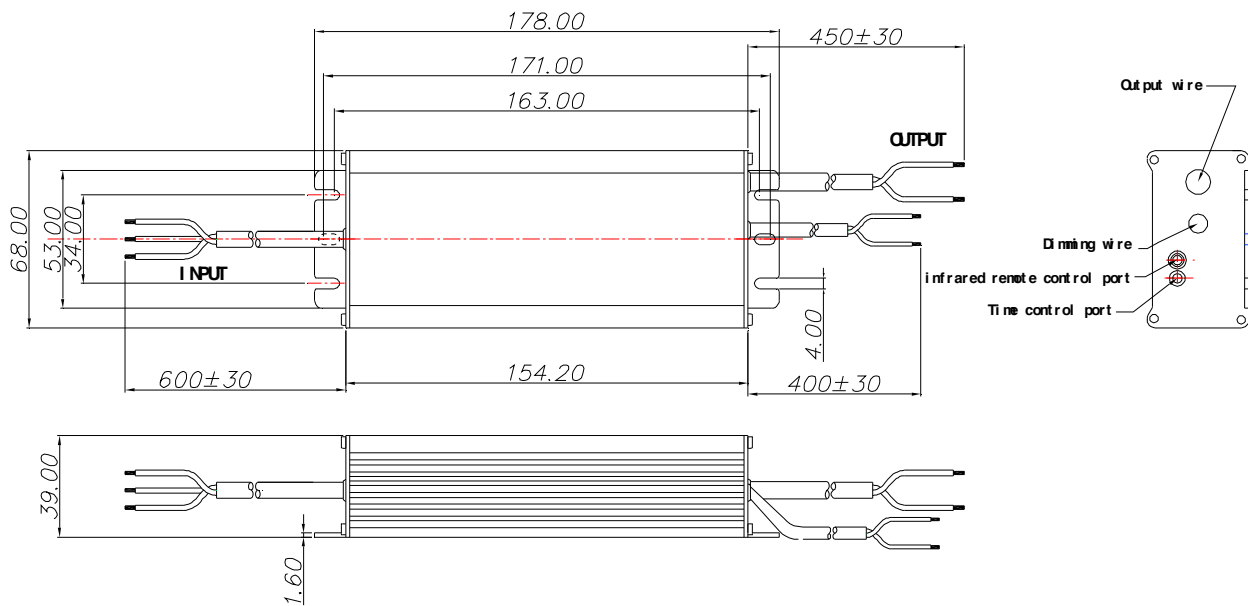

Note: Model LDP-105R150 no dimming wire.

Wire	Specification	Note
AC Input	CCC+VDE 3x1.0mm ² L=600mm	for CE
	18AWG 3C L=600mm	For UL
DC Output	CCC+VDE 2x1.0mm ² L=450mm	for CE
	18AWG 2C L=450mm	For UL
Dimming	22AWG 2C L=400mm	

14 Label

14.1 Label of CE Marking

149.00 mm

51.00 mm

Input

L Brown

G Y/G

N Blue

MOSO[®] LDP-105M150

Constant current type

Uout(No Load) : 170V[±]

Input	100-277V~ 50/60Hz, 1.5A Max.
Output	Output voltage:80-150V [±] ; Inled:0.14-1.40A, Pmax:105W Max.

MADE IN CHINA
For LED module only

Moso Power Supply Technology Co., Ltd
Bangpai Industrial Park, Guzhen, Xiaobaimang,
Gongbei Road, Nanwan District, Shenzhen City,
Guangdong Province, P.R. China

CE

IP67

t_a
Control signal
(0-10Vdc, PWM & Resistor)
Dimming Range: 10%-100%
Remote Product Control Infrared

150602W047A0001

Output

Brown +

Blue -

White DIM+

Black DIM-

(Infrared Remote Control Port)

15 0602 W047 A 0001

Y M D CODE LINE NO.

Bar code for 128 formate
Date of production need to be updated

149.00 mm

51.00 mm

Input

L Brown

G Y/G

N Blue

MOSO[®] LDP-105R150

Constant current type

Uout(No Load) : 170V[±]

Input	100-277V~ 50/60Hz, 1.5A Max.
Output	Output voltage:80-150V [±] ; Inled:0.14-1.40A, Pmax:105W Max.

MADE IN CHINA
For LED module only

Moso Power Supply Technology Co., Ltd
Bangpai Industrial Park, Guzhen, Xiaobaimang,
Gongbei Road, Nanwan District, Shenzhen City,
Guangdong Province, P.R. China

CE

IP67

t_a: 85°C
t_c: 60°C
Dimming Range: 10%-10%
Remote Product Control Infrared

150601W063A0001

Output

Brown +

Blue -

(Infrared Remote Control Port)

15 0601 W063 A 0001

Y M D CODE LINE NO.

Bar code for 128 formate
Date of production need to be updated

14.2 Label of UL Marking

149.00 mm

51.00 mm

15 0709 W047 A 0001
Y M D CODE LINE NO.

Bar code for 128 formate
Date of production need
to be updated

149.00 mm

51.00 mm

15 0608 W063 A 0001
Y M D CODE LINE NO.

Bar code for 128 formate
Date of production need
to be updated

15 Weight

755±50g

Specification for Approval

Product Name: 105W micro infrared remote control LED driver

Product Model: LDP-105M150 CE UL
 LDP-105R150 CE UL

Rev.: A.1

Sample Date: -

CUSTOMER AUTHORIZED SIGNATURE		
Tested By	Checked By	Approved By
(Company seal)Return one copy to MOSO with approved signature and company seal.		

Address: Sangtai Industrial Park Guanwai
 Xiaobaimang Songbai Road
 Nanshan District, Shenzhen
 Qty,Guangdong Province,P.R.China

Post Code: 518108

TEL: 0755-27657000 FAX: 0755-27657908

E-mail: moso@mosopower.com Web site: <http://www.mosopower.com>

Prepared By	Checked By	Approved By